

Article number: 51836479130010

Description: Vibration damper GMF 106/38

Measures

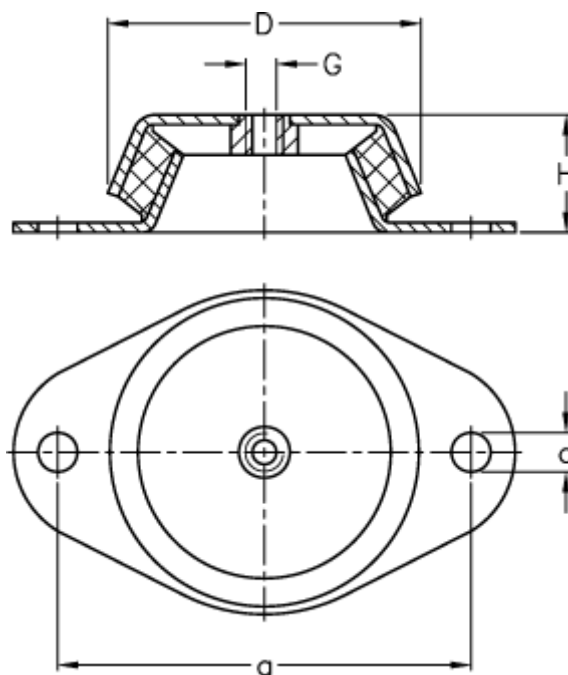

a	= 140
D	= 106
d	= 12.4
G	= M12
H	= 38
Load (daN)	= 400